

Chaotic Communications with Mutually Coupled Ring Lasers



Adam Cohen, Elizabeth Rogers, and Rajarshi Roy

Nonlinear Dynamics in Optical Systems

Institute for Research in Electronics & Applied Physics

University of Maryland at College Park

Some Definitions...

Synchronization:

process in which
similar systems come to
share identical
behavior

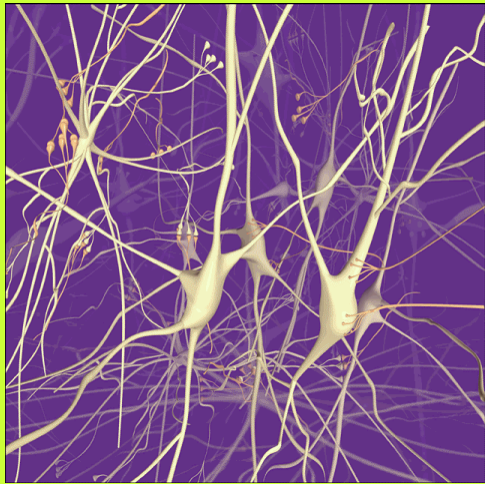

Mutual Coupling:

two or more systems
influence the dynamics
of one another

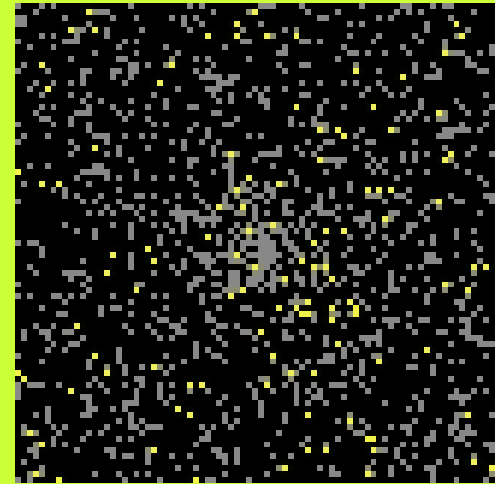

Erbium-Doped Fiber Ring Lasers

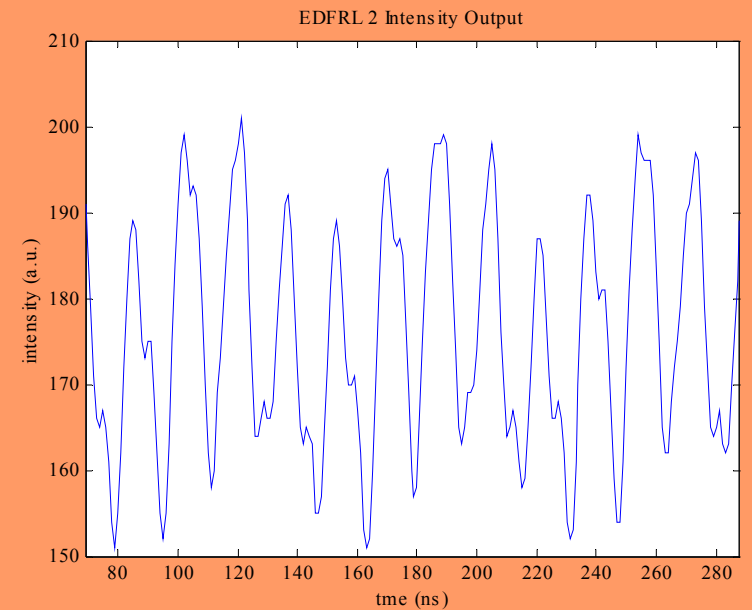
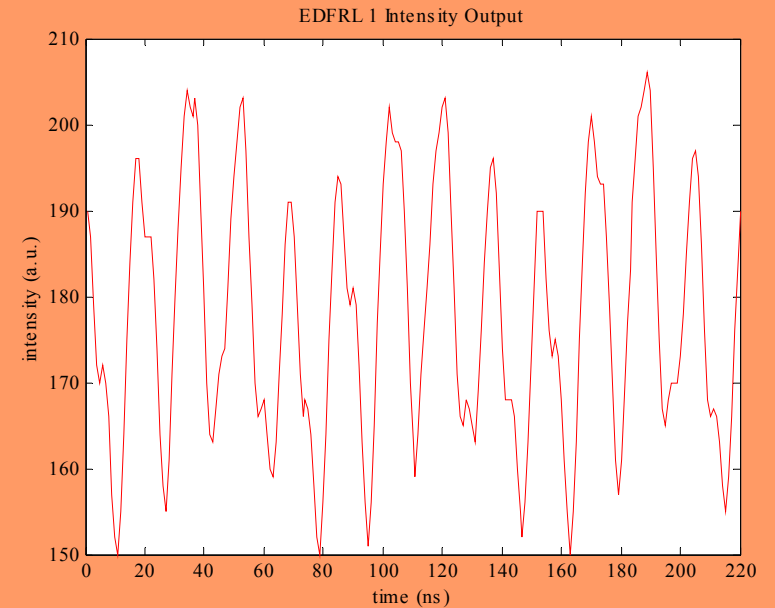
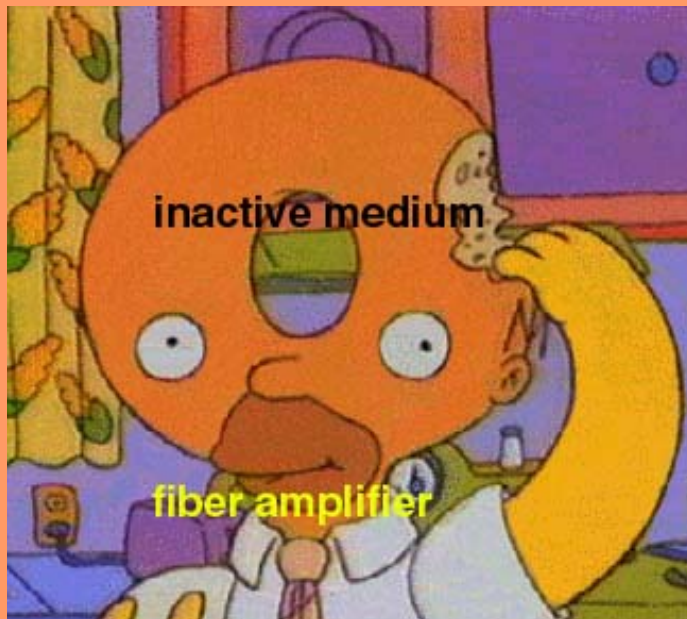
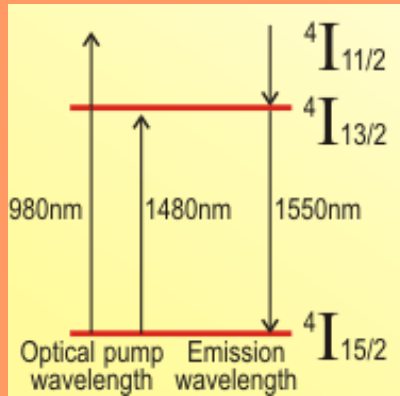

Communication Scheme Idealization

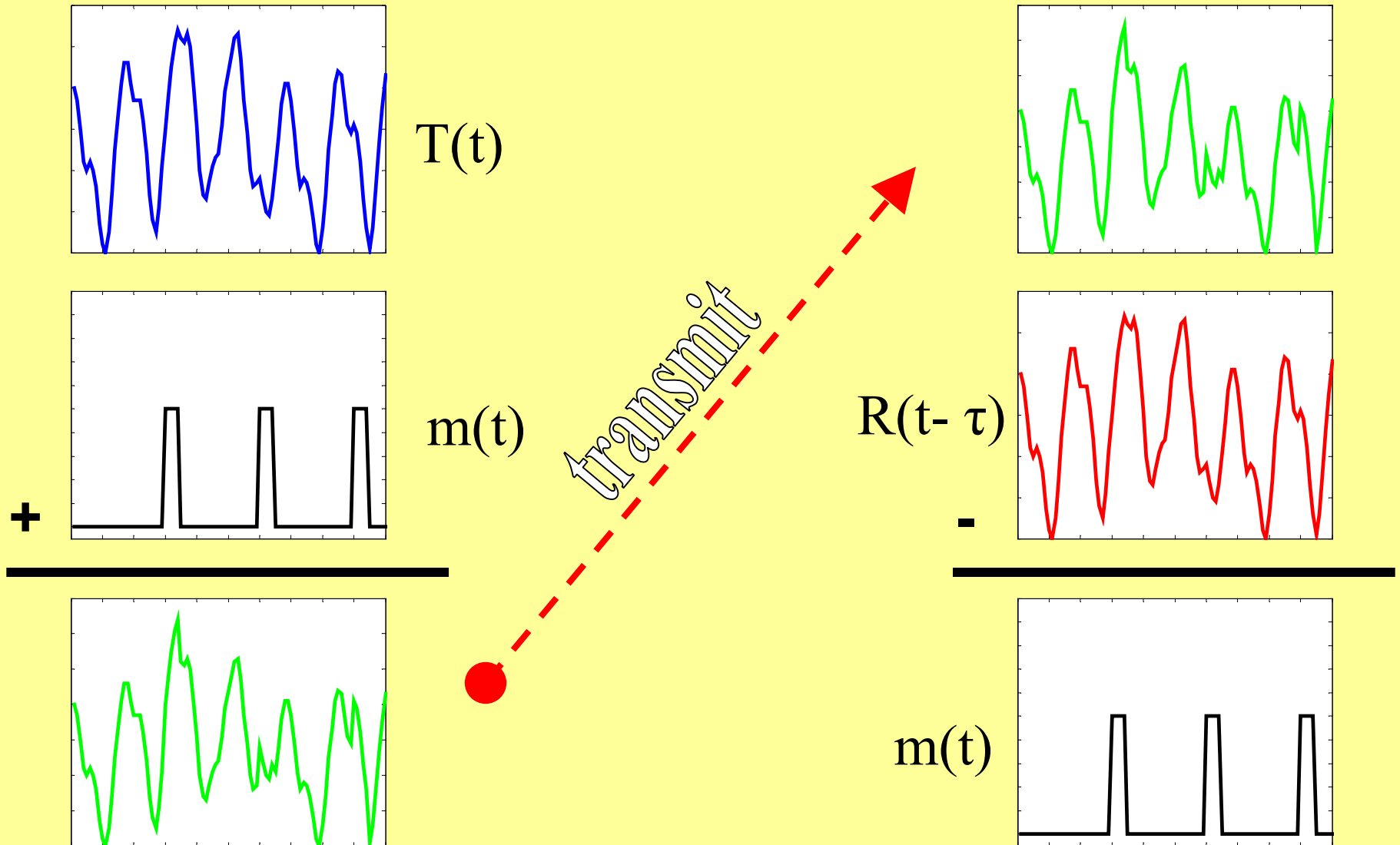

Communication Method

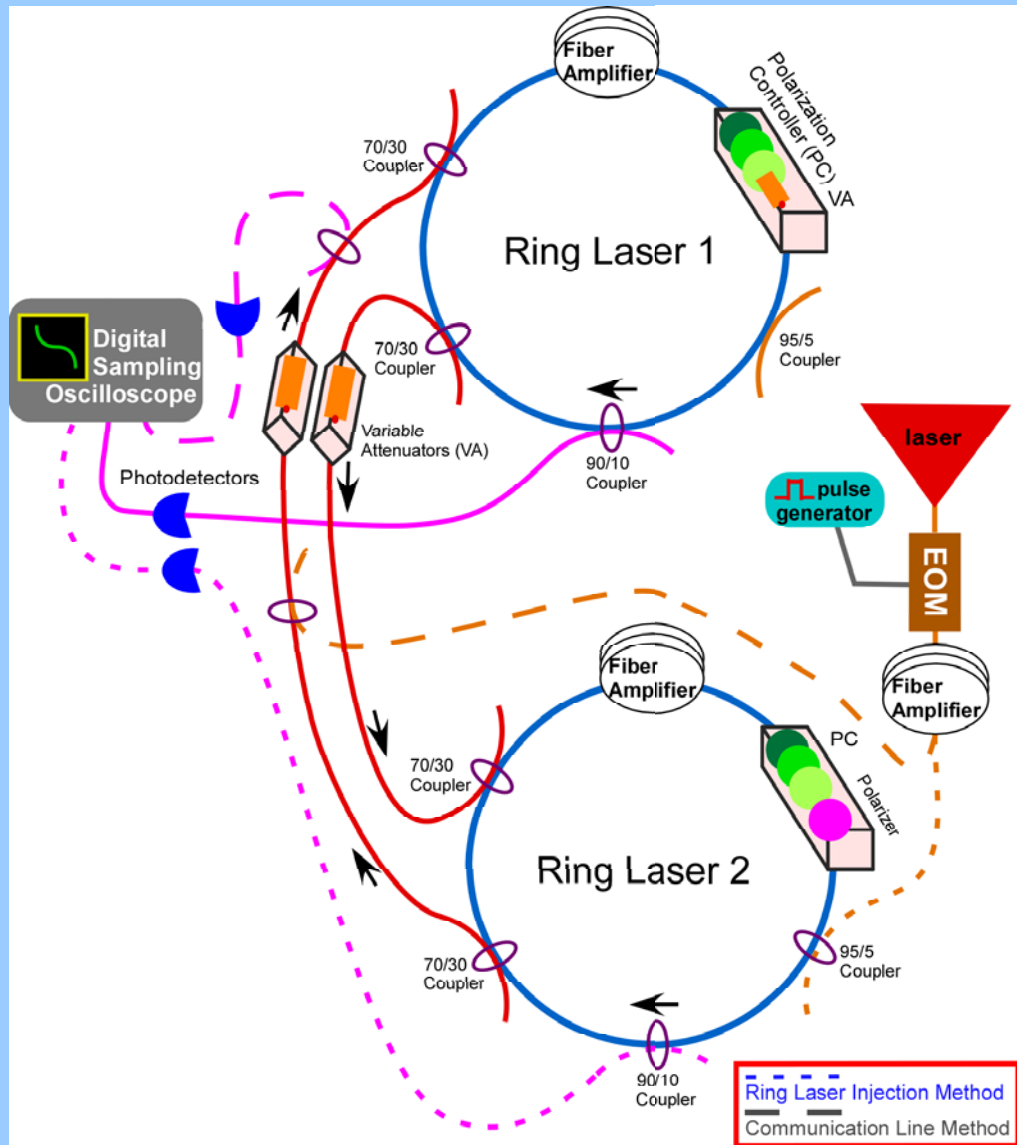

Tunable Laser

Programmable Function Generator

Electro-optic Modulator

Couplers

Photoreceivers

Oscilloscope

MATLAB

A Very Hypothetical Situation

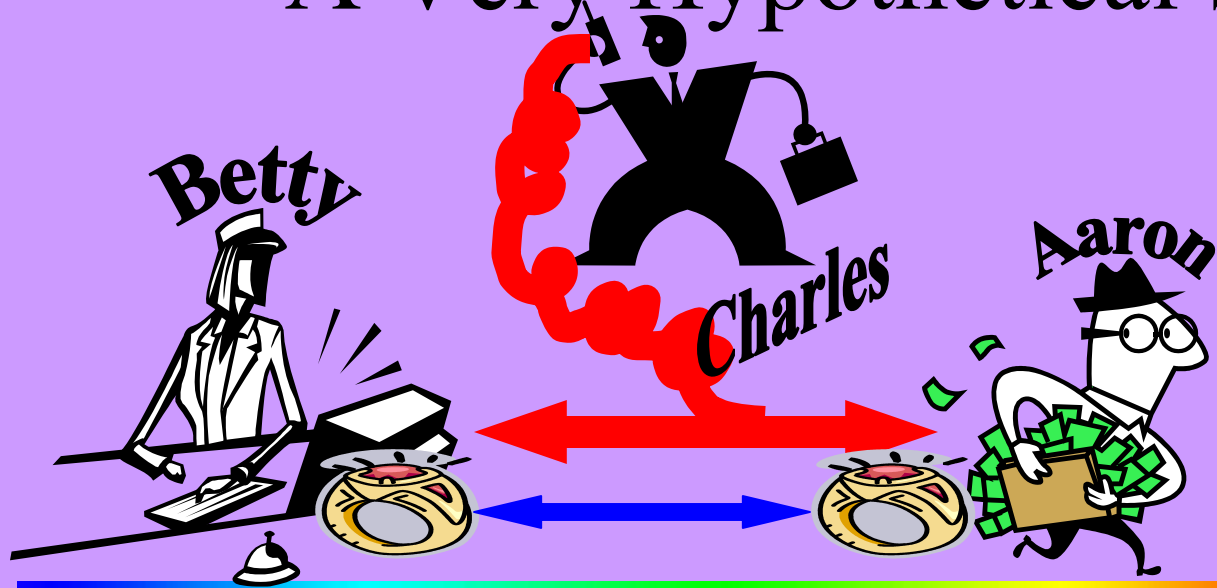

AMSC

ISR

IPST

IREAP



Time Series

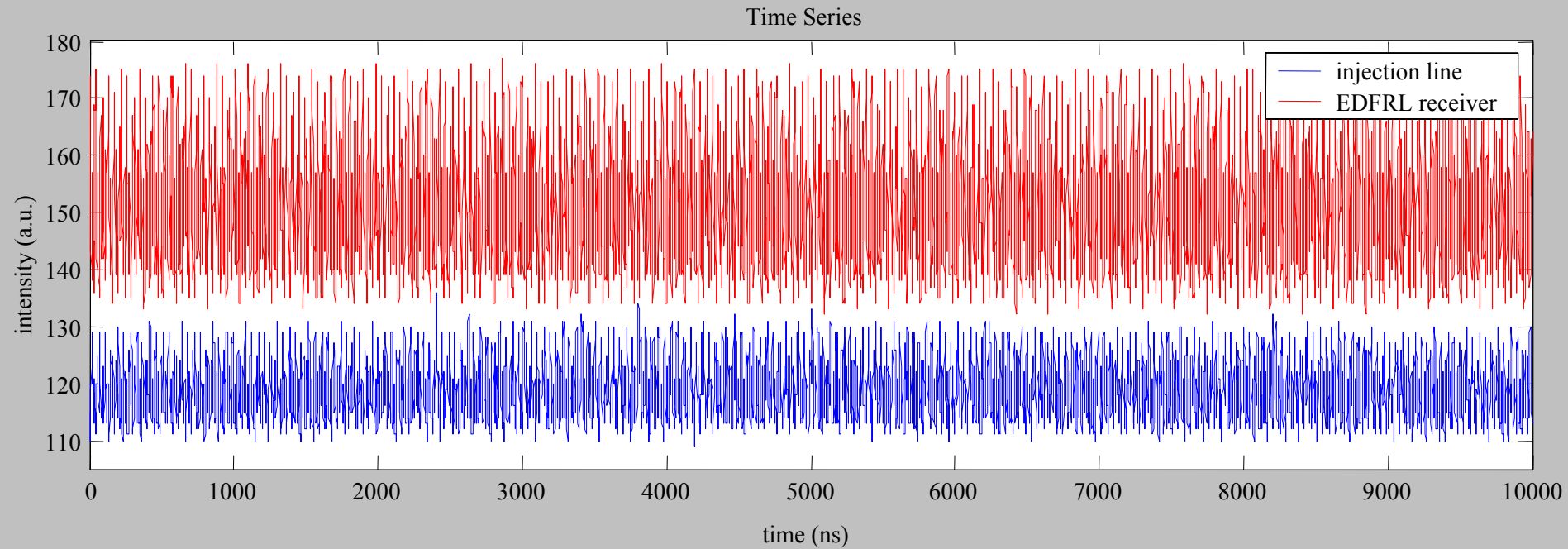

Message Recovery

Time Series Difference with Time Delay Adjustment

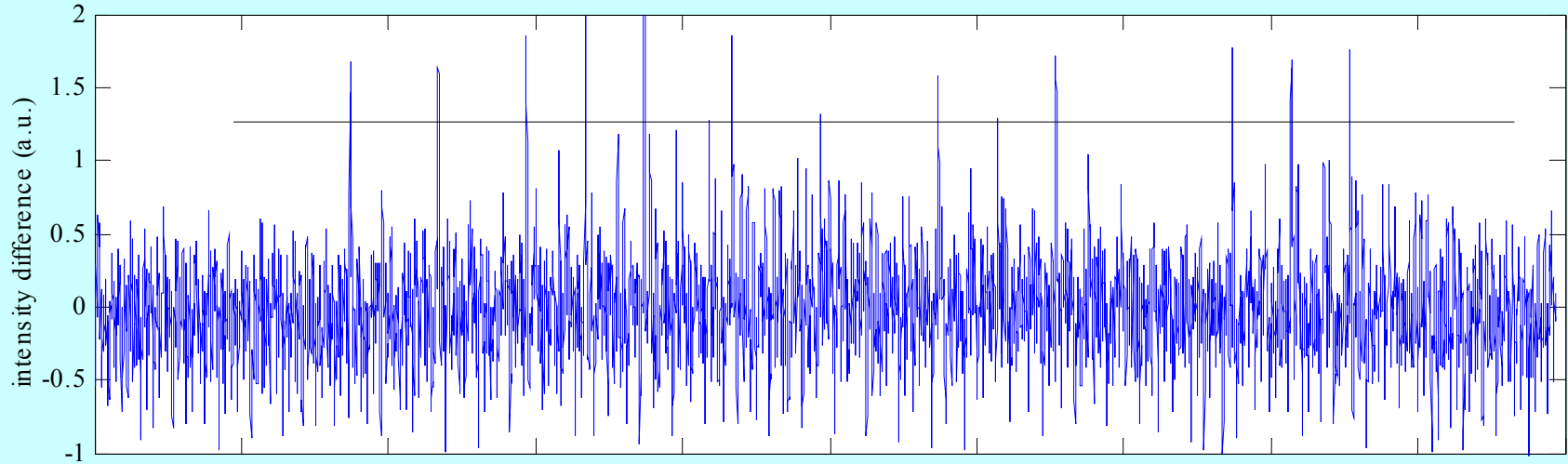

Zoomed Difference

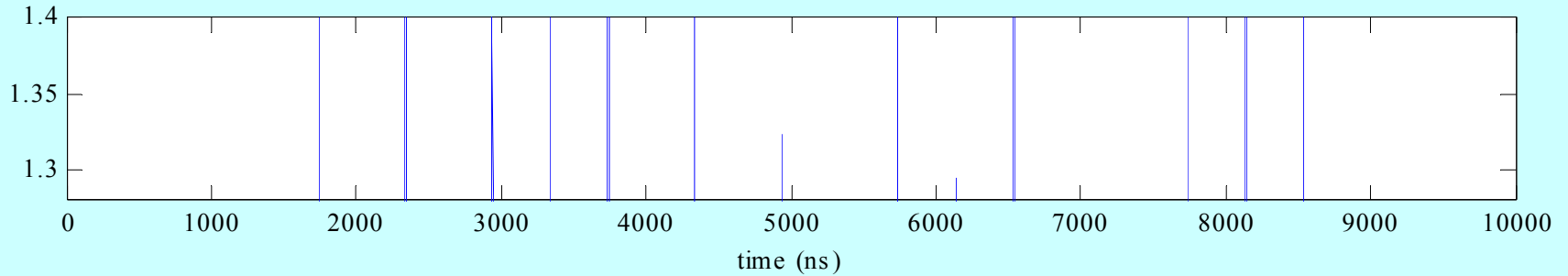

01001001 01010010 01000101 01000001 01010000

IREAP

Ringing

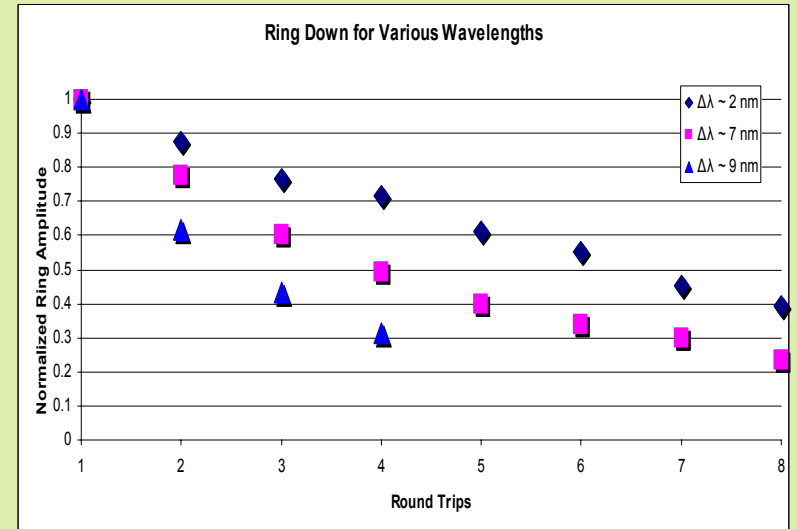
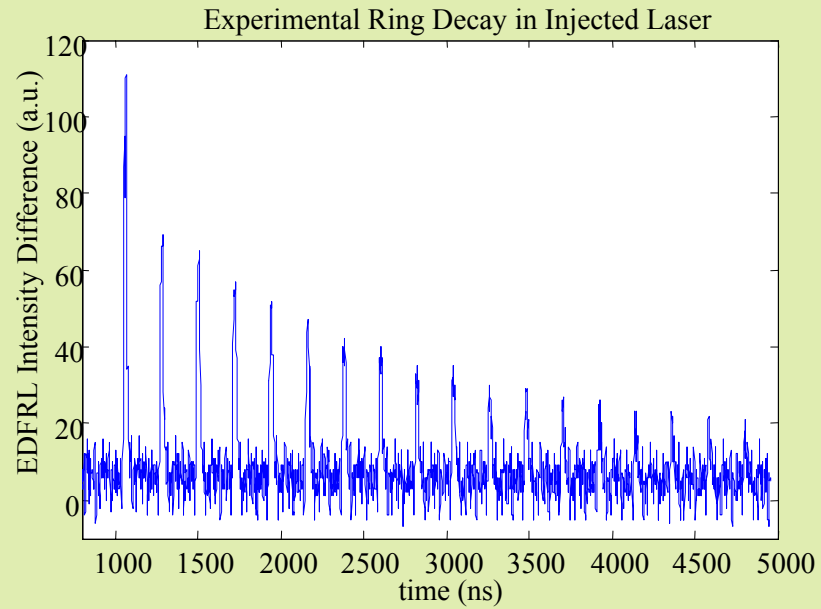

Conclusions

- Synchronization between ring lasers is easier to achieve when mutual coupling, rather than one-way coupling, is employed.
- Synchrony between mutually coupled systems is robust.
- Message encryption and decryption is a viable application of mutually coupled EDFRL systems.
- The threshold for message recovery is the same as the threshold for synchronization.